

titman

a brand of Elektron Technology

INSTRUCTIONS FOR VARIABLE WORKTOP JIG 250-1000MM

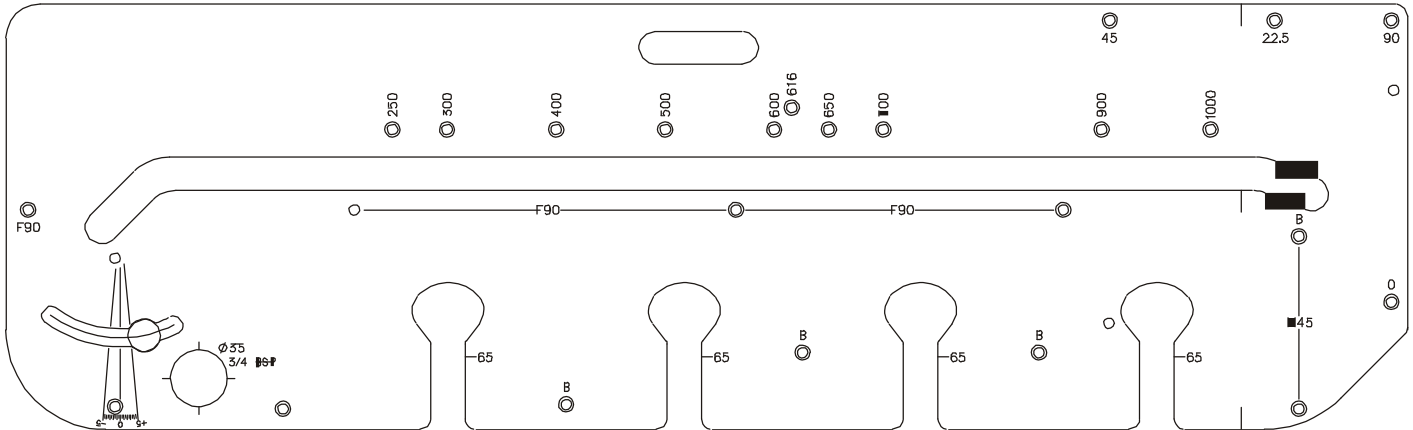

Please read these following points carefully before cutting:

1. Before using the jig we recommend you practice a few joints with off-cuts of worktops or other materials to familiarize yourself with the jig.
2. Other equipment required to use this jig:
 - Hand router with 12.7mm (1/2") collet capacity
 - A 30mm guide bush
 - Good quality tungsten carbide cutter 12.7mm x 50mm (1/2" x 2")
 - One pair of G-clamps
 -
3. Safety First:
 - Always wear protective goggles when cutting.
 - Make the path of the router clear of any obstacles
 - Make sure the cable of the router is clear of the jig.
 - The jig should be properly clamped to the worktop and supported properly on a bench or trestle.
4. When cutting:
 - Always work from left to right with no cuts deeper than 10–12mm.
 - Never withdraw the router from the jig whilst the cutter is in motion.

TYPES OF JOINTS

LEFT HAND 90° JOINT

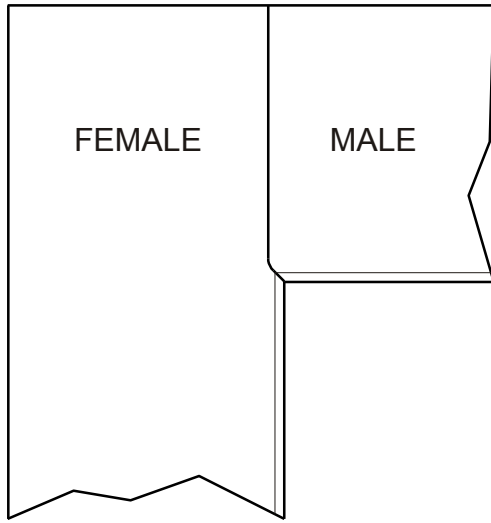

RIGHT HAND 90° JOINT

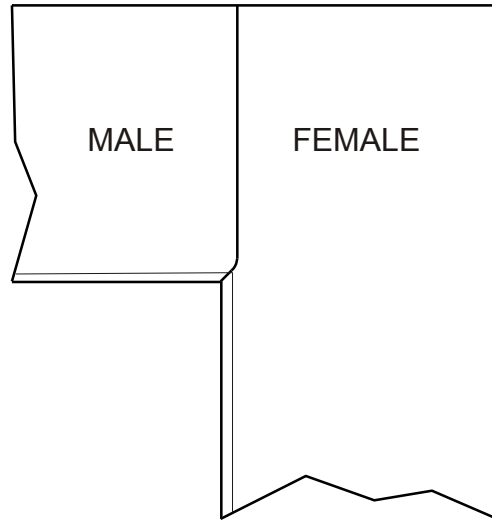

45° JOINT
(CORNER JOINT)

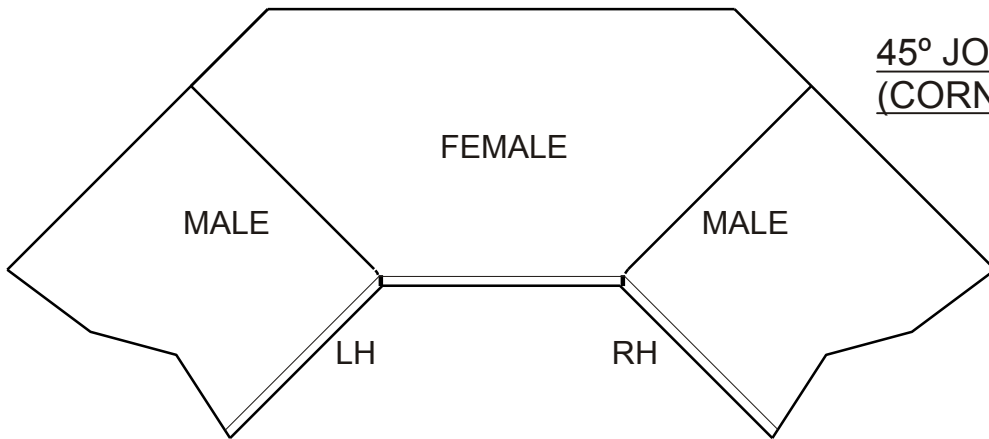

PENINSULAR JOINT

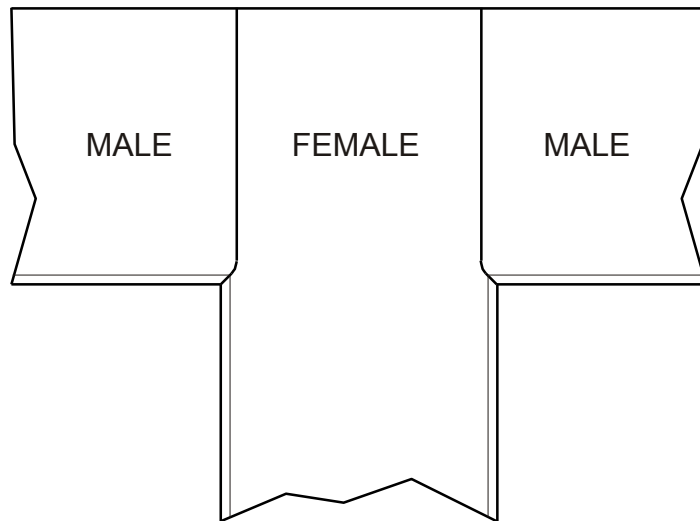

VARIABLE ANGLE SYSTEM

Note: The Variable Angle Insert is an optional accessory.

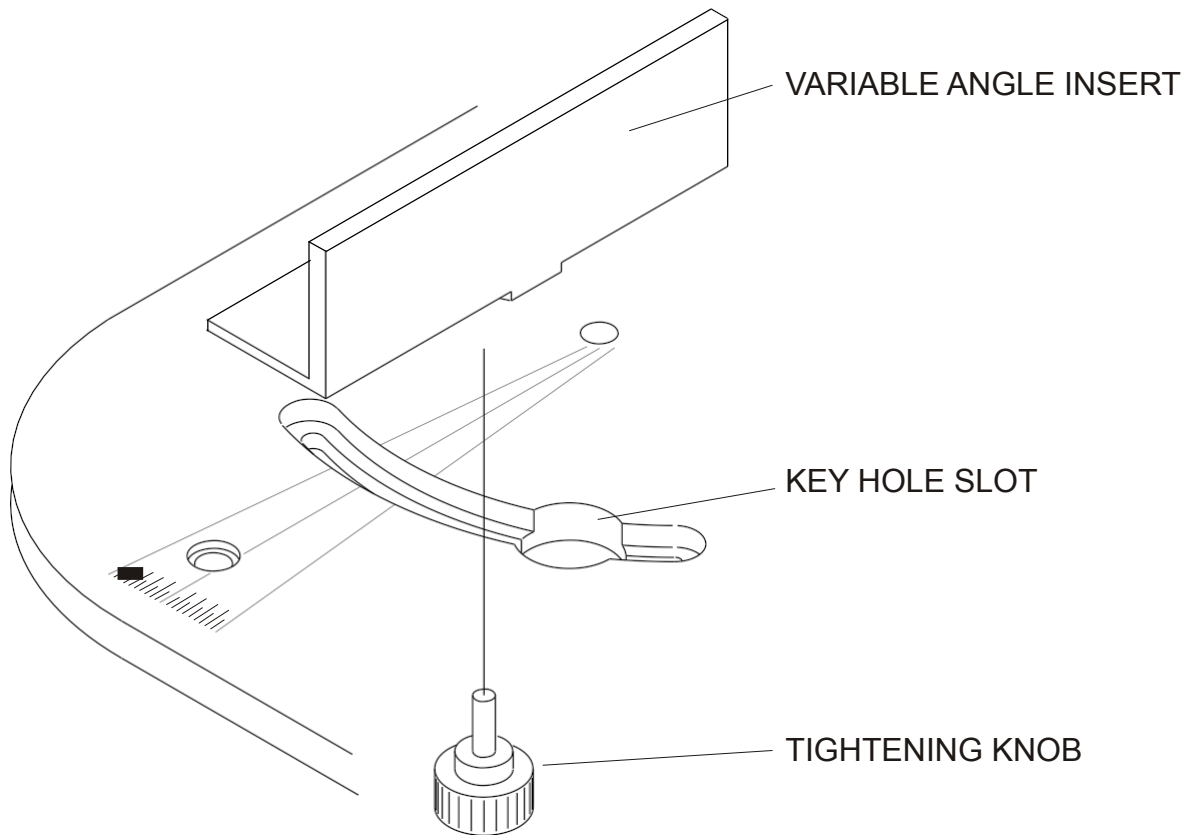

The variable angle insert can be attached to the jig to enable the user to cut worktops to an angle other than 90 degrees. The insert sits into the slot, and the tightening knob screws into the insert from below. Using the engraved markers on the jig as reference, the variable angle insert can be adjusted to change the angle of the male joint. To remove the insert from the jig just un-tighten the knob but do not remove, and slide the insert until the knob can be released through the key hole of the slot.

The out of square jig will achieve internal angles from 85 degrees to 95 degrees in a non restricted continuous movement. Current techniques to overcome non square walls are not accurate and poor joints are the result most of the time. The variable angle design will eliminate this and provide a perfectly matched joint. The extra advantage with this jig is that it can be used to find and set the angle required.

The variable angle insert can be taken out and the jig can be used exactly in the same manner as a standard worktop jig using aligning pins to accomplish joints for 90 degree walls.

This instruction leaflet will guide you on how to use the jig on standard 90 degree and 45 degree joints without the use of the variable angle insert. Towards the end of the instruction leaflet there will be instructions on how to achieve an angle which is not 90 degrees

CUTTING TO SIZE

90° JOINTS

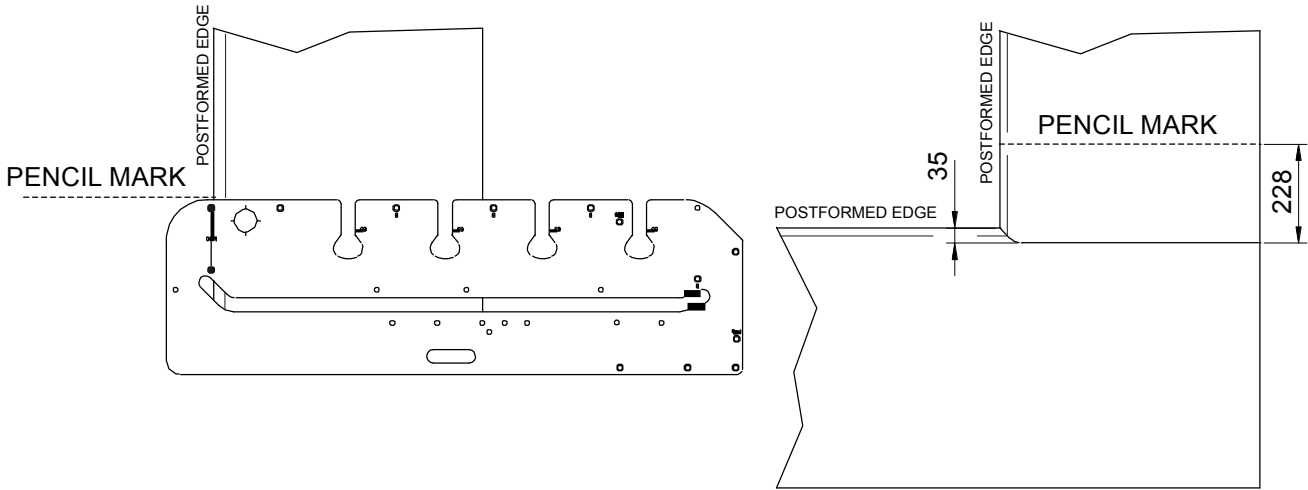

45° JOINTS

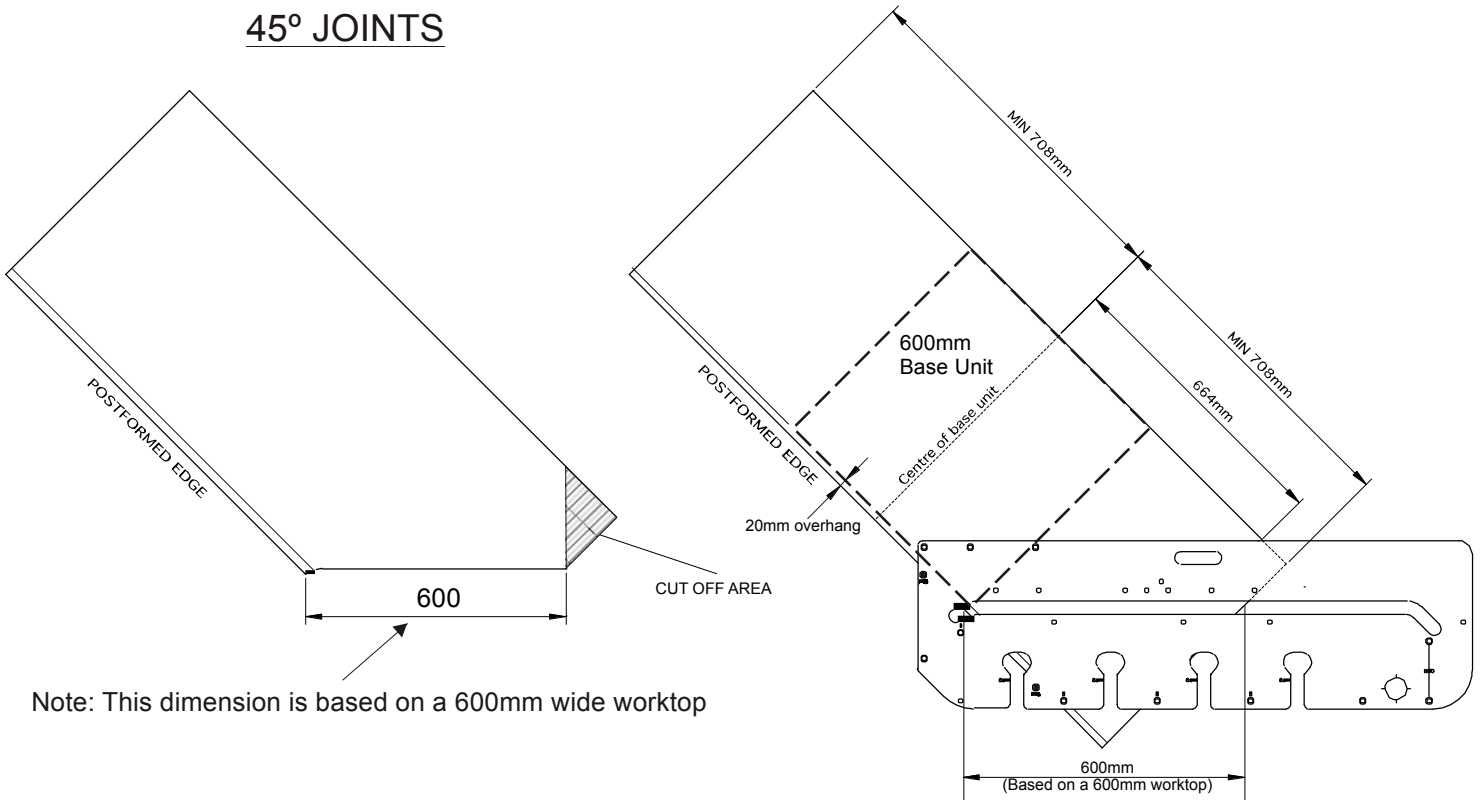

RIGHT HAND 90° JOINTS FEMALE

1. Place worktop face down and postformed edge towards you.
2. Place 3 pins in the holes marked F90.
3. Place the fourth pin the hole marked 400,500,...1000 depending on the width of the worktop.
4. Position the jig as shown in the diagram below and make sure all four pins are pushed firmly against the worktop edge.
5. Secure the jig with G-clamps.

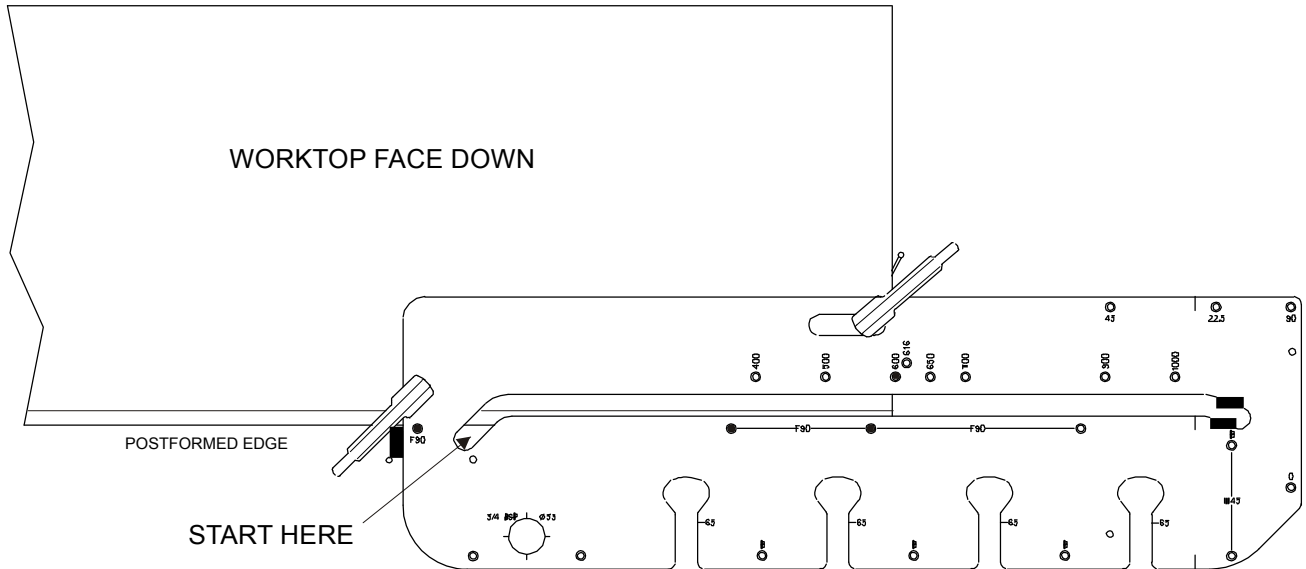

Cutting instructions

1. Set the depth of cut for 10-12mm for your first roughing cut.
2. Position the router on the left hand side of the slot and start cutting by pulling the router towards the edge of the slot closest to you.
3. Increase the depth of cut and repeat step 2 until the roughing cut is completed.
4. For the finish cut, position the router on the left hand side of the slot (with the router set for the full depth of cut) and cut by pushing the router towards the edge of the slot furthest away from you.

Cutting the slots for female joining bolts

1. Place worktop face down with the post formed edge towards you as shown in the diagram.
2. Place 3 location pins in the holes marked B as shown in the diagram.
3. Place the jig as shown in the diagram below and make sure all 3 pins are pushed firmly against the edge of the worktop.
4. Secure the jig with the G-clamps.
5. Two cuts of 10mm are required for the slots.
6. Repeat step 5 for all the slots required.

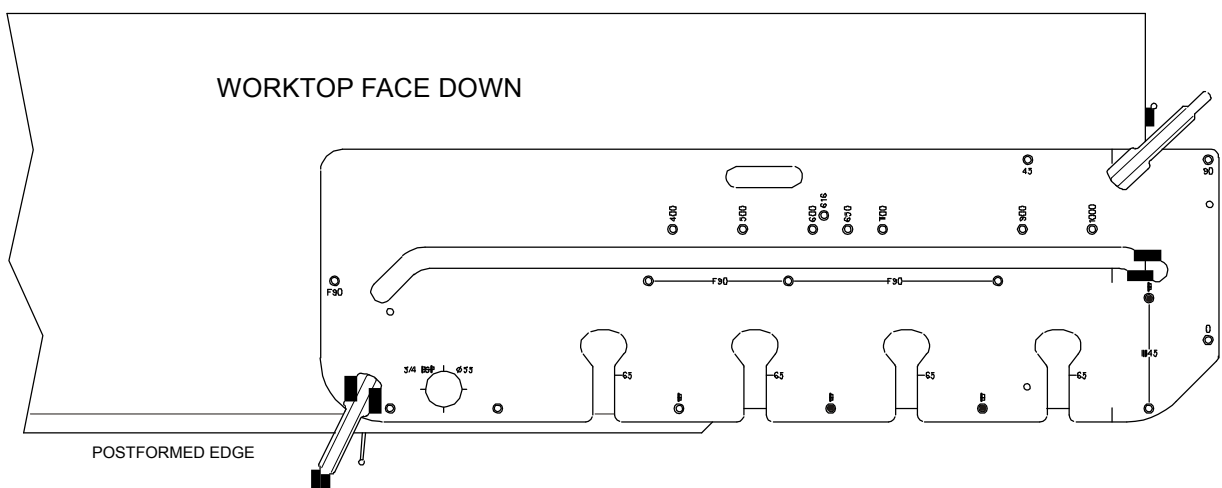

RIGHT HAND 90° JOINTS MALE

1. Place the worktop face up and the postformed edge as shown in the diagram.
2. Place 2 pins in the holes marked M90.
3. Position the jig as shown in the diagram below, and make sure both pins are pushed firmly against the worktop edge.
4. Secure the jig with G-clamps.

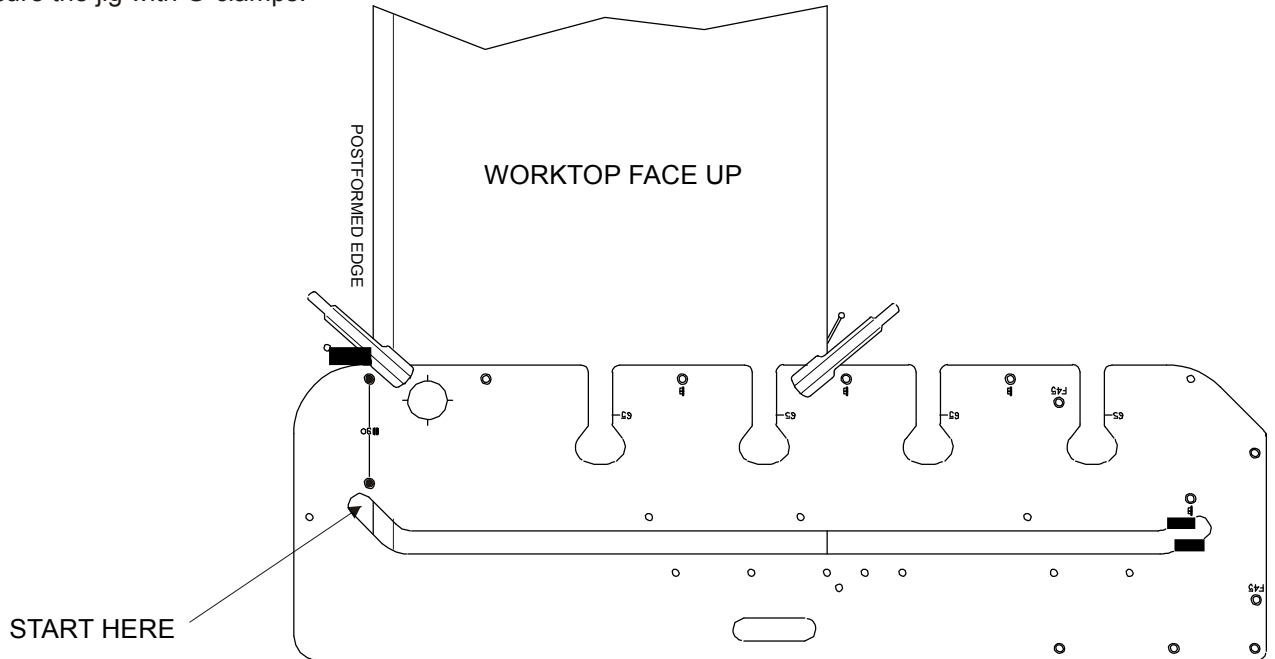

Cutting instructions

1. Set the depth of cut for 10-12mm for your first roughing cut.
2. Position the router on the left hand side of the slot and start cutting by pulling the router towards the edge of the slot closest to you.
3. Increase the depth of cut and repeat step 2 until the roughing cut is completed.
4. For the finish cut, position the router on the left hand side of the slot (with the router set for the full depth of cut) and cut by pushing the router towards the edge of the slot furthest away from you.

Cutting the slots for male joining bolts

1. Place worktop face down with the post formed edge as shown in the diagram.
2. Place 3 location pins in the holes marked B as shown in the diagram.
3. Place the jig as shown in the diagram below and make sure all 3 pins are pushed firmly against the edge of the worktop.
4. Secure the jig with the G-clamps.
5. Two cuts of 10mm are required for the slots.
6. Repeat step 5 for all the slots required.

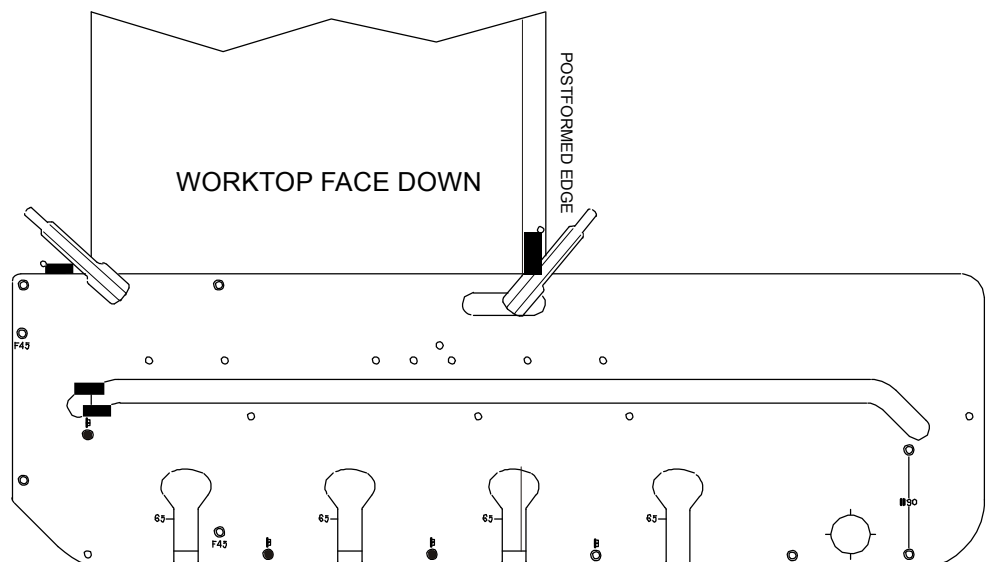

LEFT HAND 90° JOINTS FEMALE

1. Place worktop face up and postformed edge towards you.
2. Place 3 pins in the holes marked F90.
3. Place the fourth pin the hole marked 400, 500,...1000 depending on the width of the worktop.
4. Position the jig as shown in the diagram below and make sure all four pins are pushed firmly against the worktop edge.
5. Secure the jig with G-clamps.

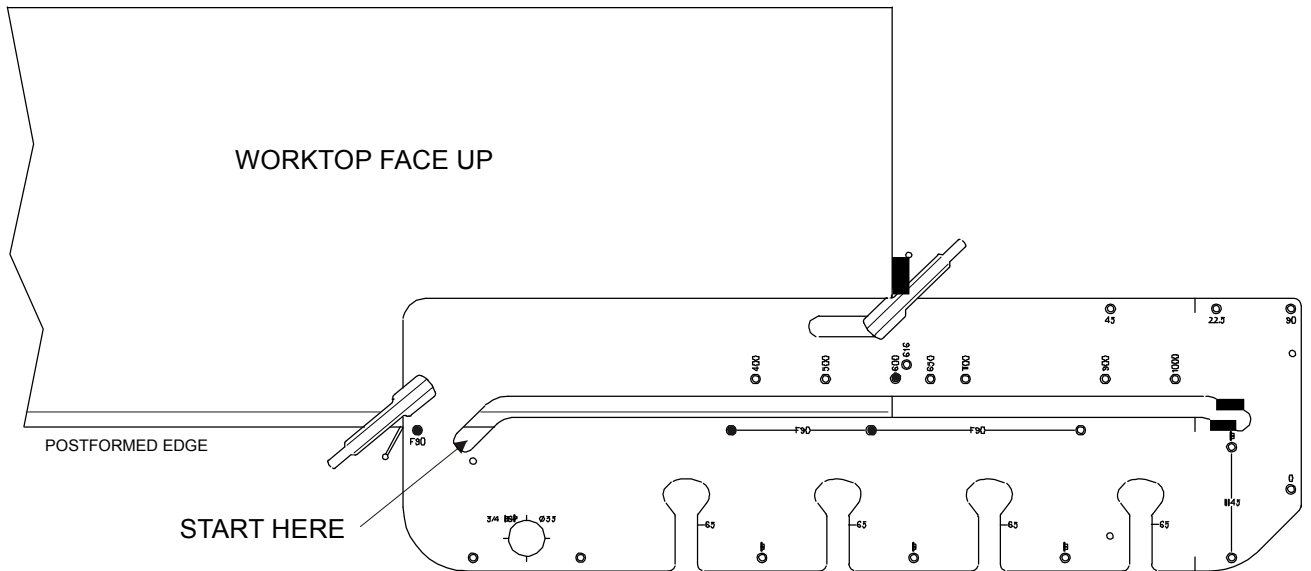

Cutting instructions

1. Set the depth of cut for 10-12mm for your first roughing cut.
2. Position the router on the left hand side of the slot and start cutting by pulling the router towards the edge of the slot closest to you.
3. Increase the depth of cut and repeat step 2 until the roughing cut is completed.
4. For the finish cut, position the router on the left hand side of the slot (with the router set for the full depth of cut) and cut by pushing the router towards the edge of the slot furthest away from you.

Cutting the slots for female joining bolts

1. Place worktop face down with the post formed edge towards you as shown in the diagram.
2. Place 3 location pins in the holes marked B as shown in the diagram.
3. Place the jig as shown in the diagram below and make sure all 3 pins are pushed firmly against the edge of the worktop.
4. Secure the jig with the G-clamps.
5. Two cuts of 10mm are required for the slots.
6. Repeat step 5 for all the slots required.

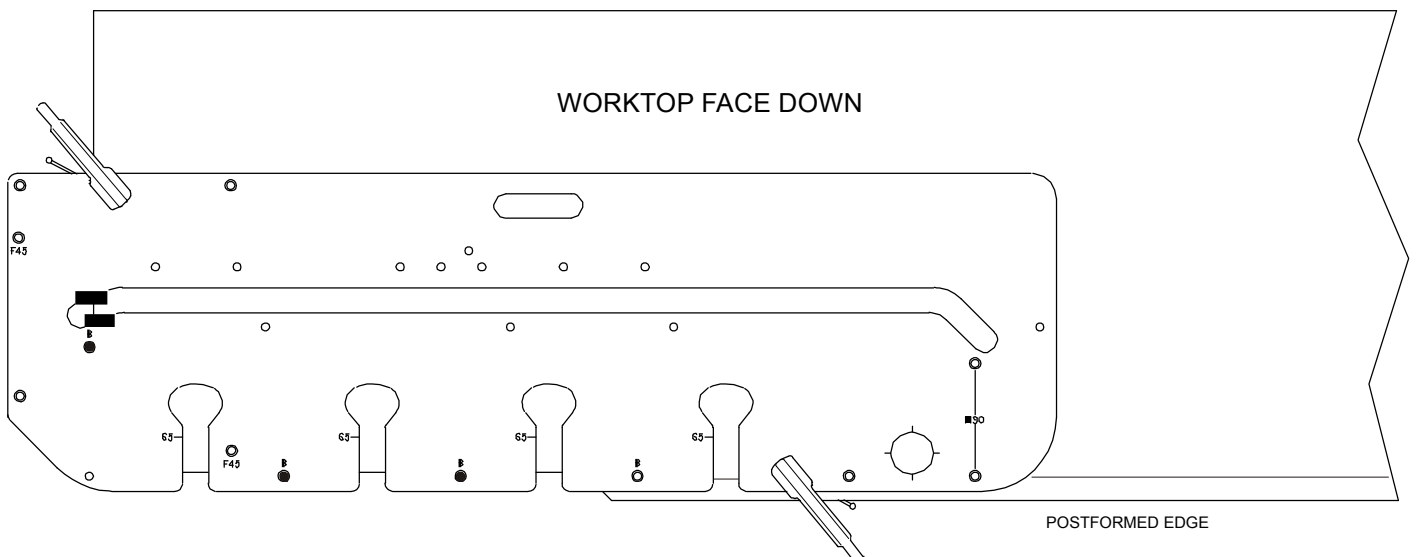

LEFT HAND 90° JOINTS MALE

1. Place the worktop face down and the postformed edge as shown in the diagram.
2. Place 2 pins in the holes marked M90.
3. Position the jig as shown in the diagram below, and make sure both pins are pushed firmly against the worktop edge.
4. Secure the jig with G-clamps.

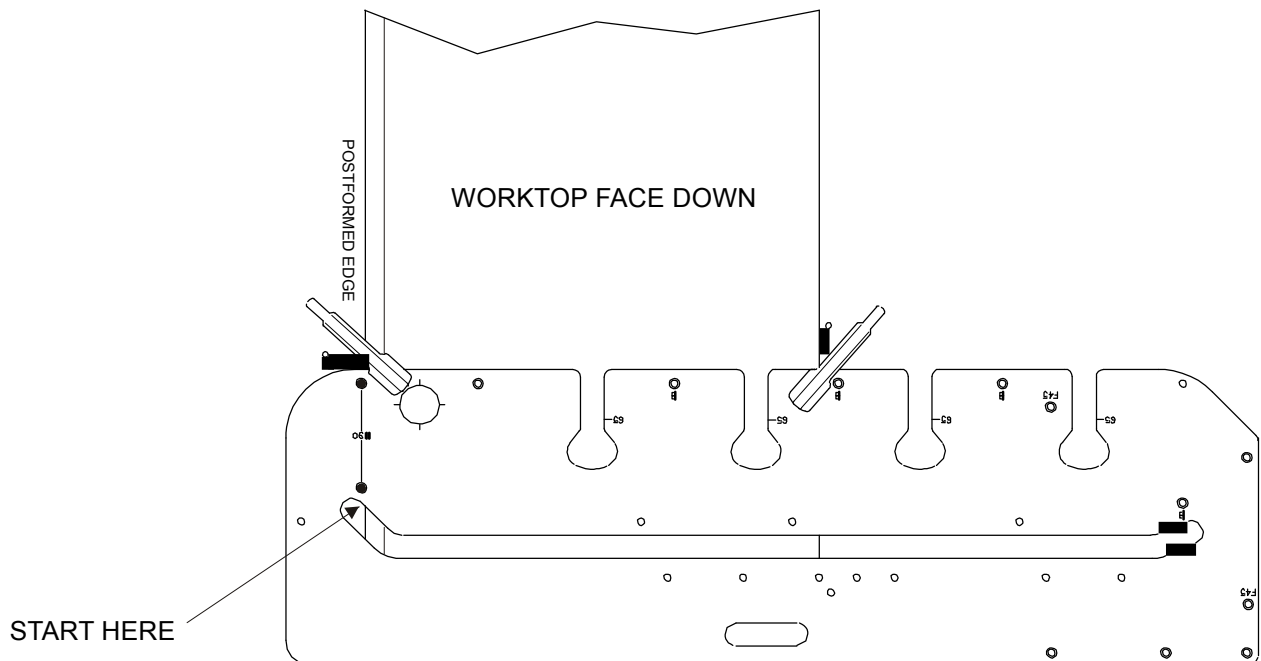

Cutting instructions

1. Set the depth of cut for 10-12mm for your first roughing cut.
2. Position the router on the left hand side of the slot and start cutting by pulling the router towards the edge of the slot closest to you.
3. Increase the depth of cut and repeat step 2 until the roughing cut is completed.
4. For the finish cut, position the router on the left hand side of the slot (with the router set for the full depth of cut) and cut by pushing the router towards the edge of the slot furthest away from you.

Cutting the slots for male joining bolts

1. Place worktop face down with the post formed edge as shown in the diagram.
2. Place 3 location pins in the holes marked B as shown in the diagram.
3. Place the jig as shown in the diagram below and make sure all 3 pins are pushed firmly against the edge of the worktop.
4. Secure the jig with the G-clamps.
5. Two cuts of 10mm are required for the slots.
6. Repeat step 5 for all the slots required.

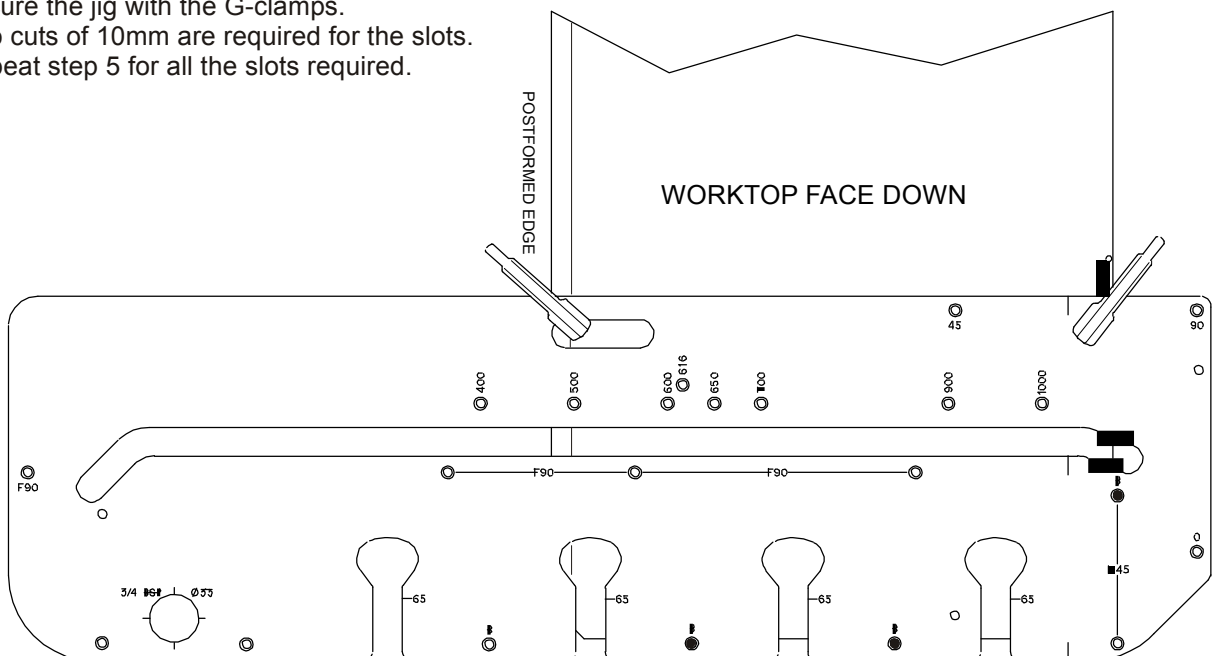

RIGHT HAND 45° JOINTS FEMALE

1. Place the worktop face up and the postformed edge as shown in the diagram.
2. Place 2 pins in the holes marked F45.
3. Position the jig as shown in the diagram below. Make sure the back edge of the jig is lined up with the pencil mark (650mm from the centre line - see cutting to size diagram).
4. Make sure both pins are pushed firmly against the worktop edge.
5. Secure the jig with the G-clamps.

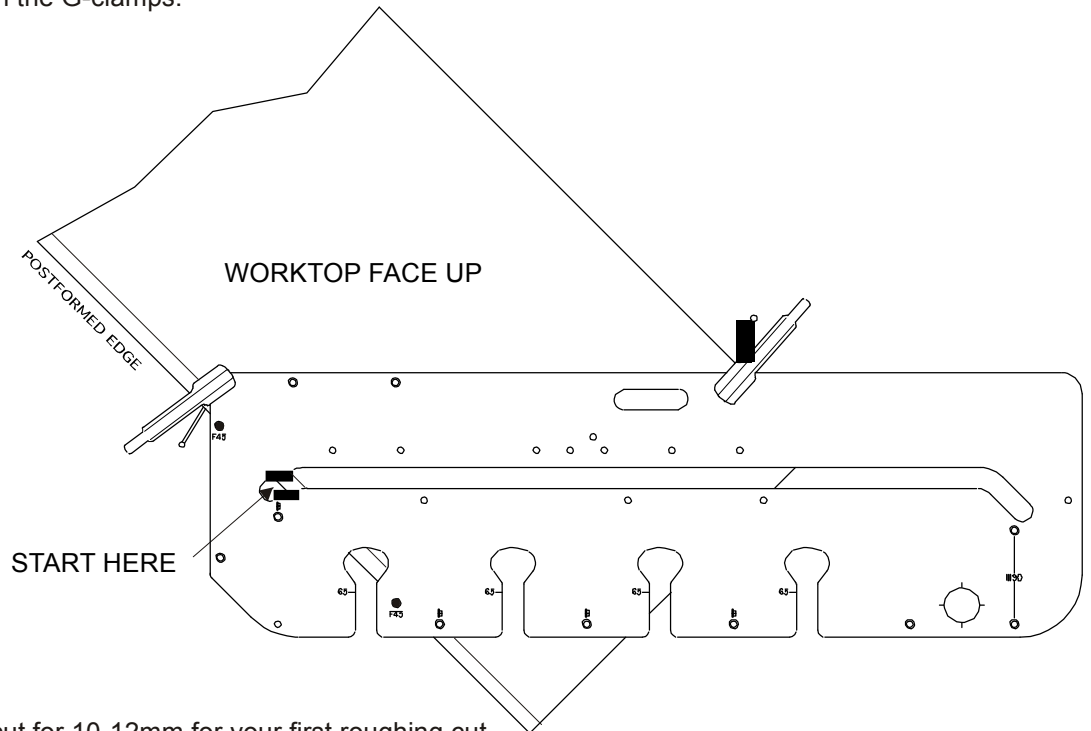

Cutting instructions

1. Set the depth of cut for 10-12mm for your first roughing cut.
2. Position the router on the left hand side of the slot and start cutting by pulling the router towards the edge of the slot closest to you.
3. Increase the depth of cut and repeat step 2 until the roughing cut is completed.
4. For the finish cut, position the router on the left hand side of the slot (with the router set for the full depth of cut) and cut by pushing the router towards the edge of the slot furthest away from you.

Cutting the slots for female joining bolts

1. Place worktop face down with the post formed edge as shown in the diagram.
2. Make sure the shaded area is cut off for the appropriate width of the worktop (see cutting to size diagram).
3. Place 3 location pins in the holes marked B as shown in the diagram.
4. Place the jig as shown in the diagram below and make sure all 3 pins are pushed firmly against the edge of the worktop.
5. Secure the jig with the G-clamps.
6. Two cuts of 10mm are required for the slots.
7. Repeat step 5 for all the slots required.

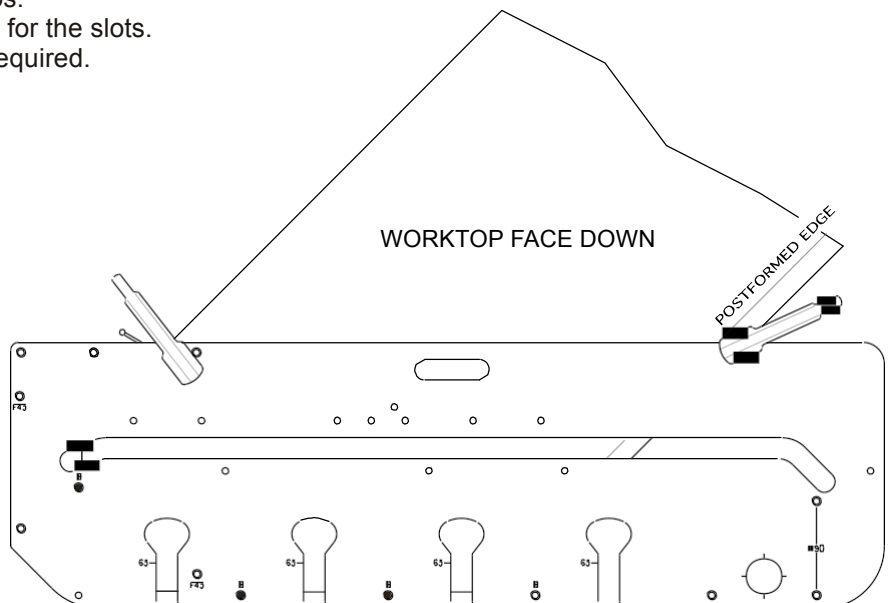

RIGHT HAND 45° JOINTS MALE

1. Place the worktop face down and the postformed edge as shown in the diagram.
2. Place 2 pins in the holes marked M45.
3. Position the jig as shown in the diagram below, and make sure both pins are pushed firmly against the worktop edge.
4. Secure the jig with the G-clamps.

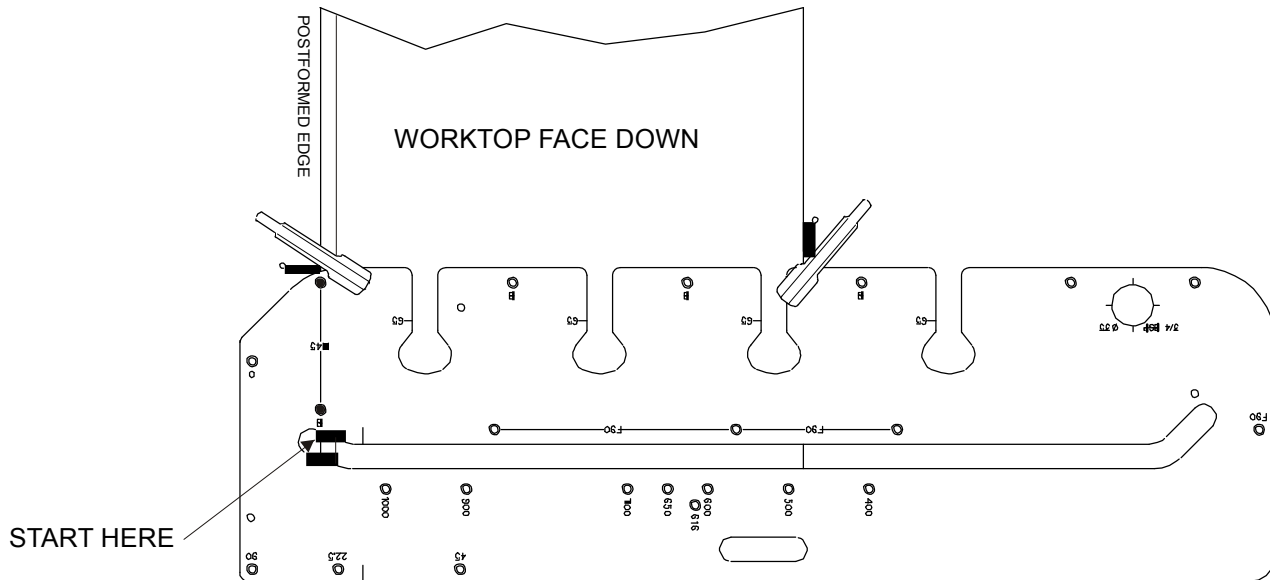

Cutting instructions

1. Set the depth of cut for 10-12mm for your first roughing cut.
2. Position the router on the left hand side of the slot and start cutting by pulling the router towards the edge of the slot closest to you.
3. Increase the depth of cut and repeat step 2 until the roughing cut is completed.
4. For the finish cut, position the router on the left hand side of the slot (with the router set for the full depth of cut) and cut by pushing the router towards the edge of the slot furthest away from you.

Cutting the slots for male joining bolts

1. Place worktop face down with the post formed edge as shown in the diagram.
2. Place 3 location pins in the holes marked B as shown in the diagram.
3. Place the jig as shown in the diagram below and make sure all 3 pins are pushed firmly against the edge of the worktop.
4. Secure the jig with the G-clamps.
5. Two cuts of 10mm are required for the slots.
6. Repeat step 5 for all the slots required.

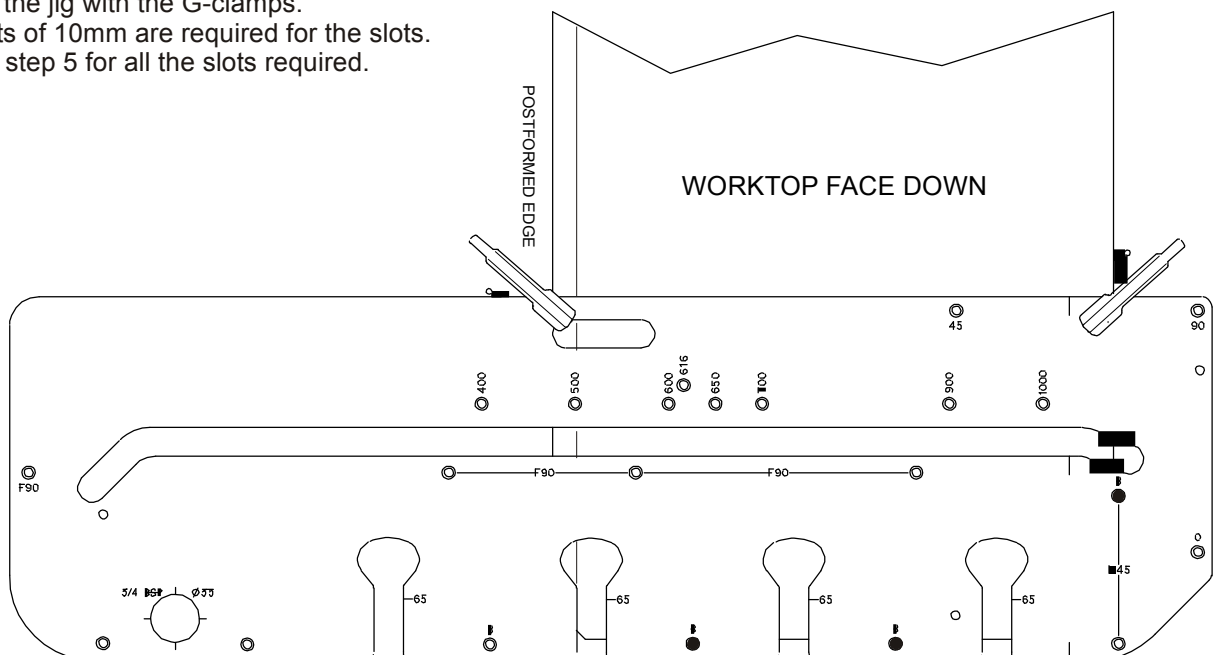

LEFT HAND 45° JOINTS FEMALE

1. Place the worktop face down and the postformed edge as shown in the diagram.
2. Place 2 pins in the holes marked F45.
3. Position the jig as shown in the diagram below. Make sure the back edge of the jig is lined up with the pencil mark (650mm from the centre line - see cutting to size diagram).
4. Make sure both pins are pushed firmly against the worktop edge.
5. Secure the jig with the G-clamps.

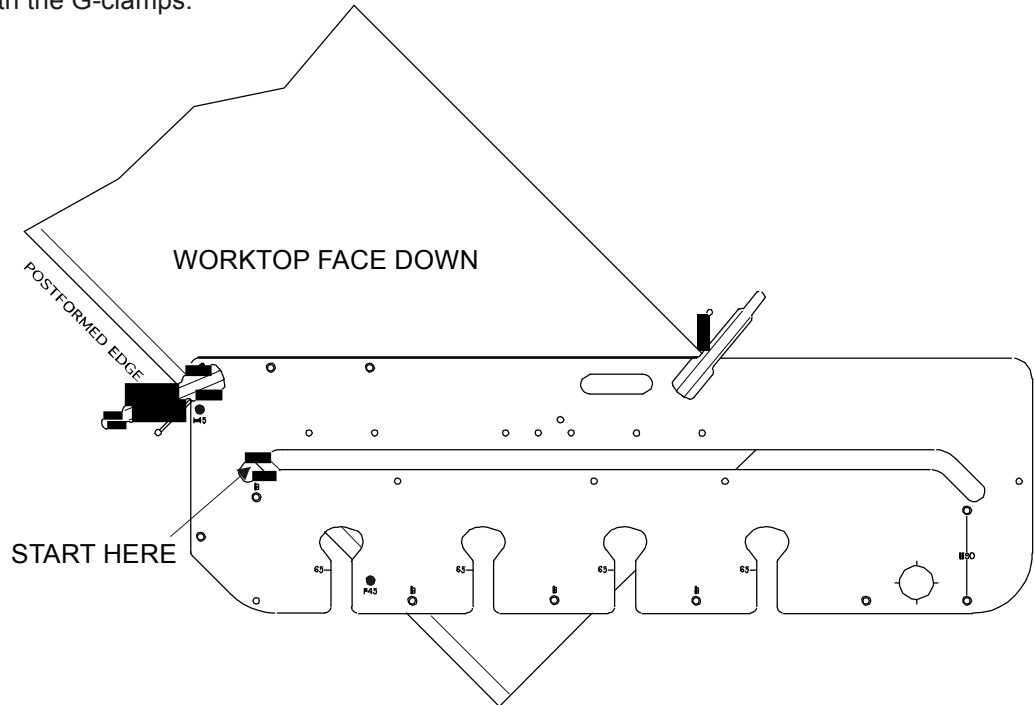

Cutting instructions

1. Set the depth of cut for 10-12mm for your first roughing cut.
2. Position the router on the left hand side of the slot and start cutting by pulling the router towards the edge of the slot closest to you.
3. Increase the depth of cut and repeat step 2 until the roughing cut is completed.
4. For the finish cut, position the router on the left hand side of the slot (with the router set for the full depth of cut) and cut by pushing the router towards the edge of the slot furthest away from you.

Cutting the slots for female joining bolts

1. Place worktop face down with the post formed edge as shown in the diagram.
2. Make sure the shaded area is cut off for the appropriate width of the worktop (see cutting to size diagram).
3. Place 3 location pins in the holes marked B as shown in the diagram.
4. Place the jig as shown in the diagram below and make sure all 3 pins are pushed firmly against the edge of the worktop.
5. Secure the jig with the G-clamps.
6. Two cuts of 10mm are required for the slots.
7. Repeat step 5 for all the slots required.

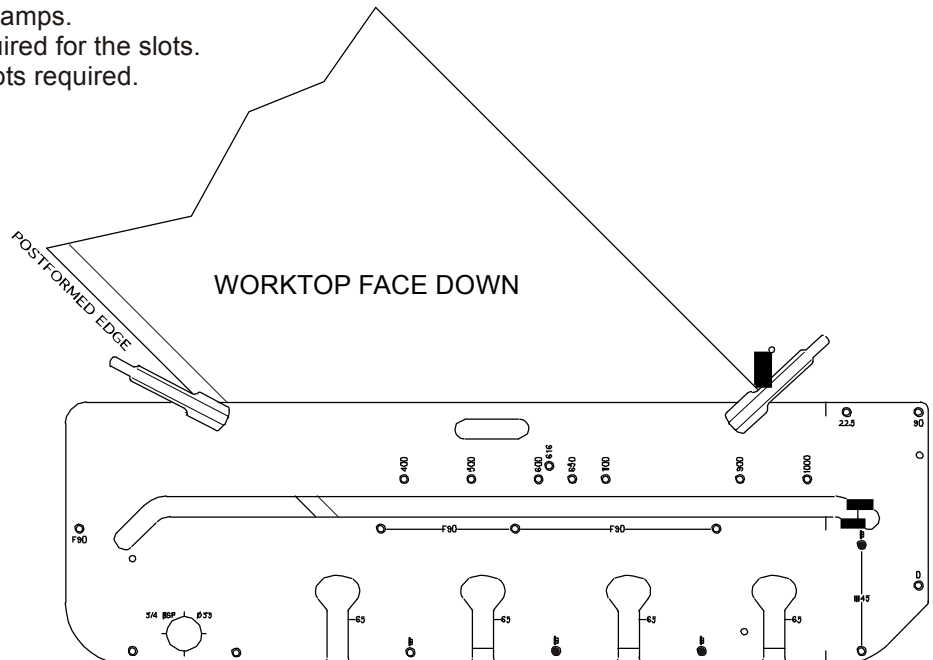

LEFT HAND 45° JOINTS MALE

1. Place the worktop face up and the postformed edge as shown in the diagram.
2. Place 2 pins in the holes marked M45.
3. Position the jig as shown in the diagram below, and make sure both pins are pushed firmly against the worktop edge.
4. Secure the jig with the G-clamps.

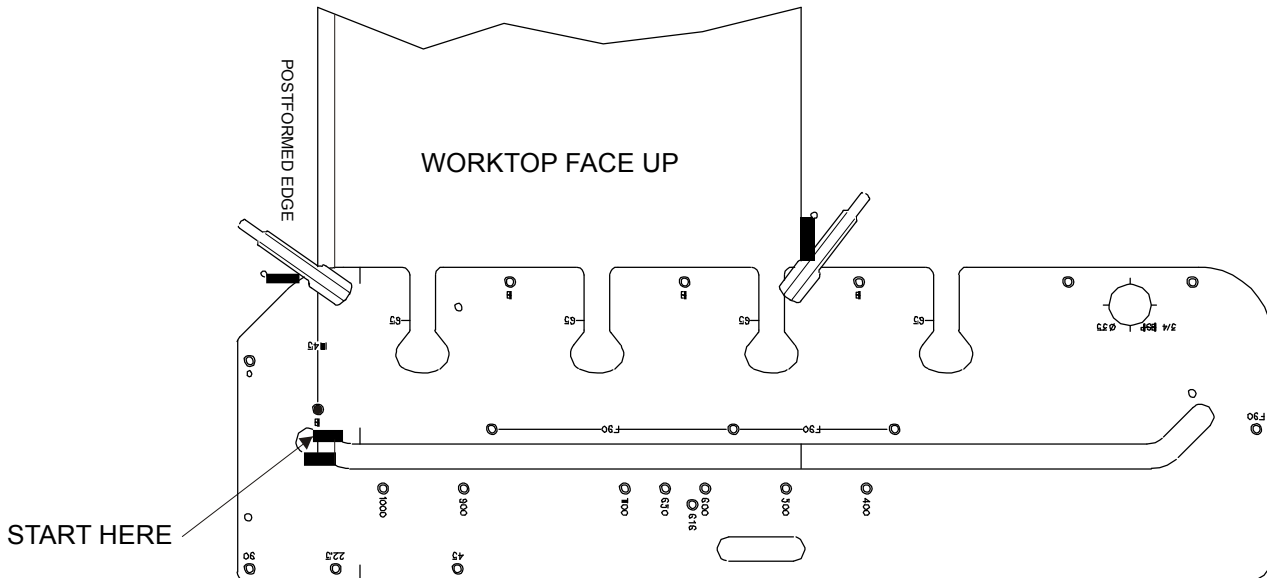

Cutting instructions

1. Set the depth of cut for 10-12mm for your first roughing cut.
2. Position the router on the left hand side of the slot and start cutting by pulling the router towards the edge of the slot closest to you.
3. Increase the depth of cut and repeat step 2 until the roughing cut is completed.
4. For the finish cut, position the router on the left hand side of the slot (with the router set for the full depth of cut) and cut by pushing the router towards the edge of the slot furthest away from you.

Cutting the slots for male joining bolts

1. Place worktop face down with the post formed edge as shown in the diagram.
2. Place 3 location pins in the holes marked B as shown in the diagram.
3. Place the jig as shown in the diagram below and make sure all 3 pins are pushed firmly against the edge of the worktop.
4. Secure the jig with the G-clamps.
5. Two cuts of 10mm are required for the slots.
6. Repeat step 5 for all the slots required.

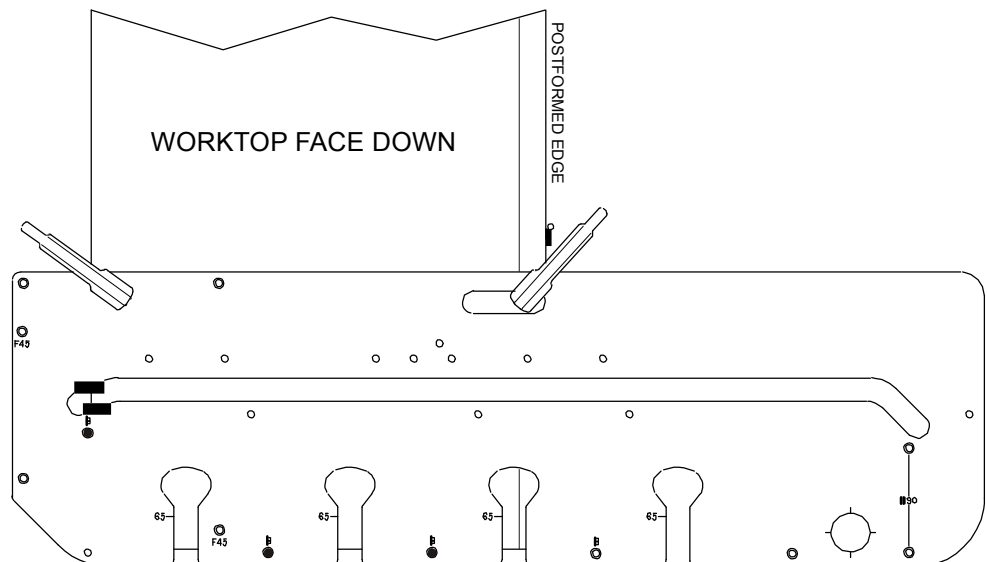

VARIABLE ANGLE SYSTEM

Note: The Variable Angle Insert is an optional accessory.

If the internal walls are not 90 degrees where a worktop needs to go then the variable angle insert is used. Assemble the insert as described on page 3.

1. Cut the end of the female worktop to the correct angle. Cut a female joint referring to the instructions on left or right hand 90° joints female. Locate the female worktop into position (see diagram below).

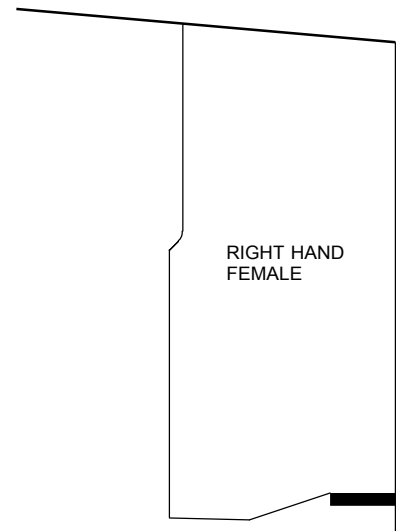
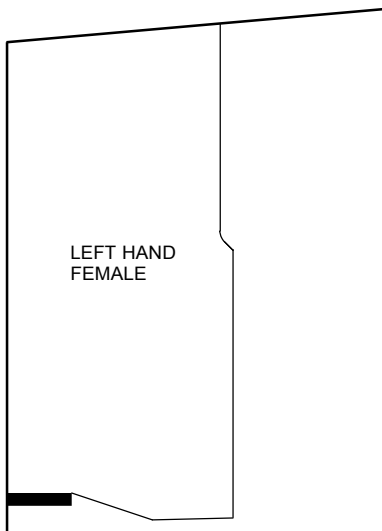

If the angle of the male joint is known then the variable angle insert can be moved to the correct position indicated by the angle increments on the jig. If the angle is not known then the jig itself can be used to set the position of the angle adjustment plate.

2. The female worktop must be in position. Locate the male worktop into position - you may have to overlap the female worktop. Position the jig as shown below, whether a left hand or right hand joint is needed. Adjust the angle adjustment plate so that it is flat against the male worktop and tighten into position.
3. Cut out the male worktop in exactly the same way as a standard male 90 degree joint, but use the insert instead of aligning pins to position the jig.

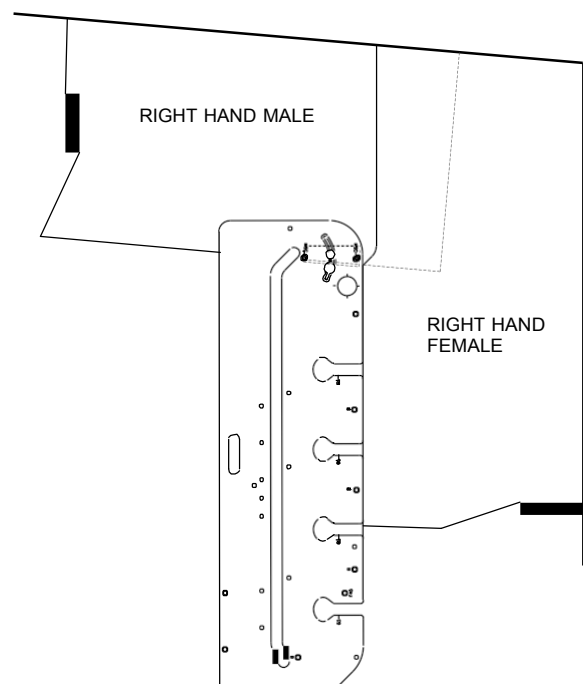
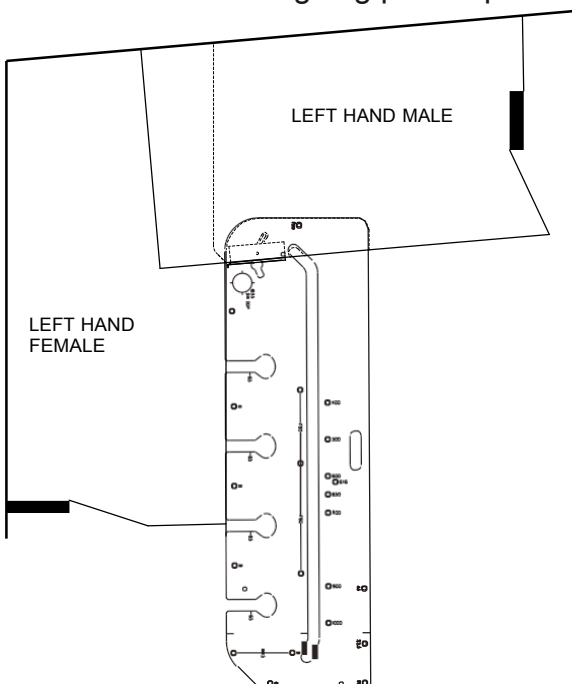

EXTRA FEATURES

CUTTING ANGLES/CHAMFERS

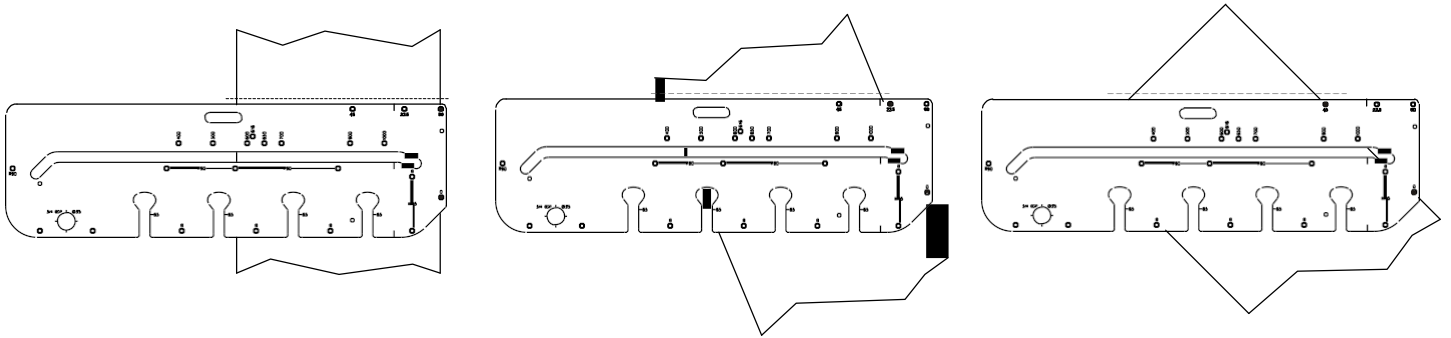

1. Place a pin in the hole marked 0, and another pin in the hole corresponding to the angle you require, 90°, 22.5°, or 45°.
2. Position the jig as shown in the corresponding diagram above.
3. Use top edge of jig to mark the required angle, or secure with G-clamps and use top edge of the jig as a guided edge for cutting.

Note: If using a router then make sure the cutter cuts into the postformed edge to avoid chipping and do not set the router to cut more than 12mm per pass.

Note: If using a router the cut will be 9mm away from the worktop edge because of the bush/cutter offset. Take this into consideration when positioning the jig.

SQUARE END CUTTING WORKTOPS

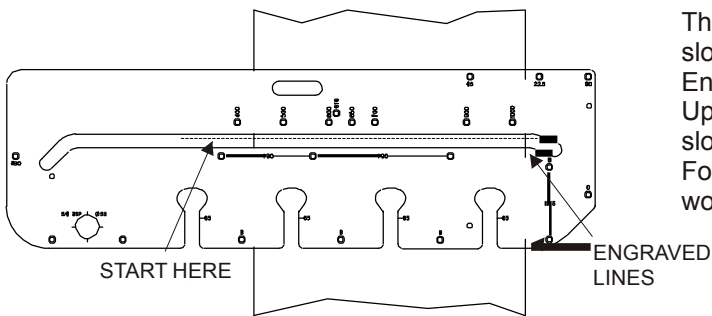

The jig can be used to square cut the worktop using the central slot.

Engraved lines on the jig correspond to the edge of the worktop. Up to 950mm wide worktops can be square cut using the central slot as a router guide.

Follow the cutting instructions on previous pages to cut the worktop.

CUTTING CABINET DOOR HINGE RECESSES

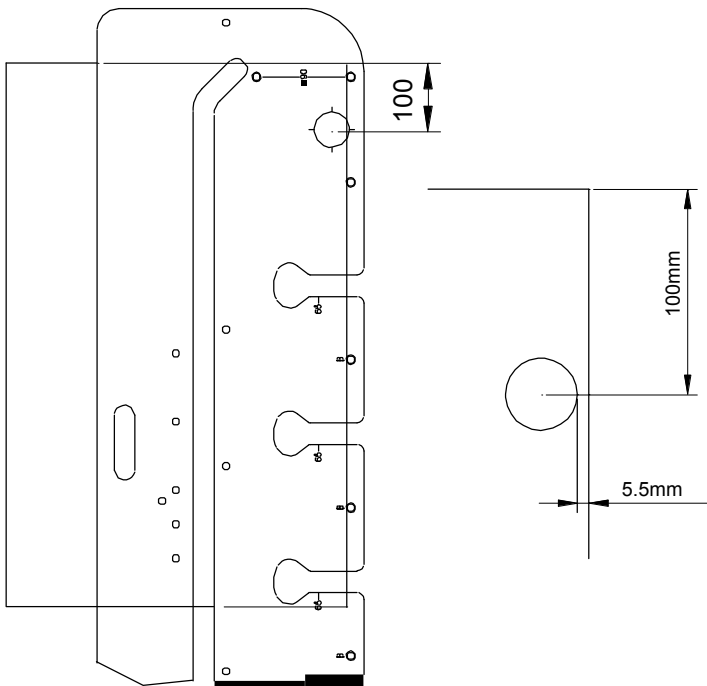

1. Mark the position of the hinge on the door. The centre of the holes should be roughly 100mm from the top of the door to give the required support, ensure this measurement is as accurate as possible.
2. Position 2 pins in the holes marked in the diagram left.
3. Position the jig as shown in the diagram with the 2 pins pushed up against the edge of the door.
4. Secure the jig with G-clamps.
5. Set the depth for 10mm.
6. Commence cutting of the recess making sure to clean out the material in the centre of the hole as well as round the edge.
7. Repeat step 5, increasing the cut by 2mm, therefore setting the total depth for 12mm. (This should be enough clearance for most hinges. Adjust this value if you require holes for thicker hinge heads).